

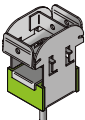
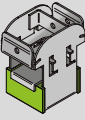
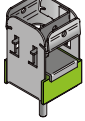
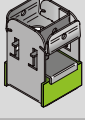
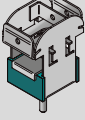
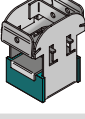
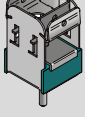

# AKUSTIK + sylomer<sup>®</sup>

## CEILING MOUNTS

### Akustik Super + Sylomer<sup>®</sup> y Akustik Sierra + Sylomer<sup>®</sup>: Range

REF. AMC	SUMMARY	(KG) MAX. LOAD	CODE
 Akustik Super T60 + Sylomer <sup>®</sup> 75 Type A	Metal armor of the Akustik Super secured to the ceiling by an M6 screw.	75	23851
 Akustik Super T60 + Sylomer <sup>®</sup> 75 Type B	Metal armor of the Akustik Super secured to the ceiling by an M6 screw.	75	23852
 Akustik Super T47 + Sylomer <sup>®</sup> 75 Type A	Metal armor of the Akustik Super secured to the ceiling by an M6 screw.	75	23841
 Akustik Super T47 + Sylomer <sup>®</sup> 75 Type B	Metal armor of the Akustik Super secured to the ceiling by an M6 screw.	75	23842
 Akustik Super T60 + Sylomer <sup>®</sup> 30 Type A	Metal armor of the Akustik Super secured to the ceiling by an M6 screw.	30	23831
 Akustik Super T60 + Sylomer <sup>®</sup> 30 Type B	Metal armor of the Akustik Super secured to the ceiling by an M6 screw.	30	23832
 Akustik Super T47 + Sylomer <sup>®</sup> 30 Type A	Metal armor of the Akustik Super secured to the ceiling by an M6 screw.	30	23821
 Akustik Super T47 + Sylomer <sup>®</sup> 30 Type B	Metal armor of the Akustik Super secured to the ceiling by an M6 screw.	30	23822
 Akustik Sierra + Sylomer <sup>®</sup> 75 Type A	<b>NEW</b> Ventana fijada al techo mediante tornillo M6. Además, incorpora elemento de FIXING al perfil de gran sencillez.	75	23865
 Akustik Sierra + Sylomer <sup>®</sup> 75 Type B	<b>NEW</b> Ventana fijada al techo mediante tuerca soldada M6. Además, incorpora elemento de FIXING al perfil de gran sencillez.	75	23866
 Akustik Sierra + Sylomer <sup>®</sup> 30 Type A	<b>NEW</b> Ventana fijada al techo mediante tornillo M6. Además, incorpora elemento de FIXING al perfil de gran sencillez.	30	23863
 Akustik Sierra + Sylomer <sup>®</sup> 30 Type B	<b>NEW</b> Ventana fijada al techo mediante tuerca soldada M6. Además, incorpora elemento de FIXING al perfil de gran sencillez.	30	23864

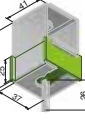
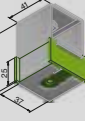
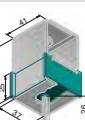
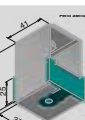
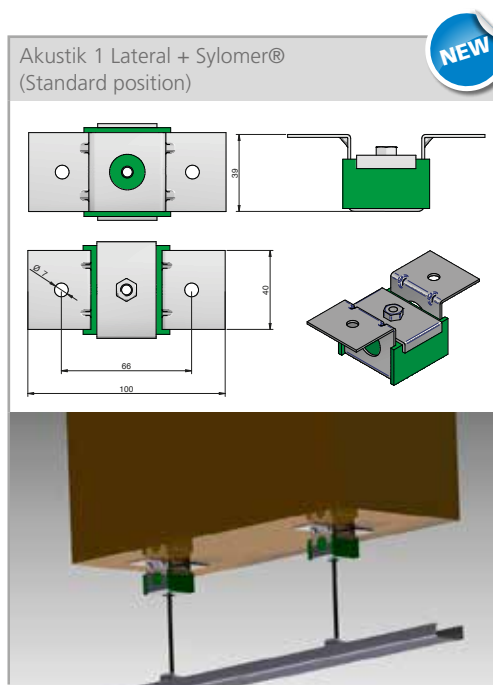
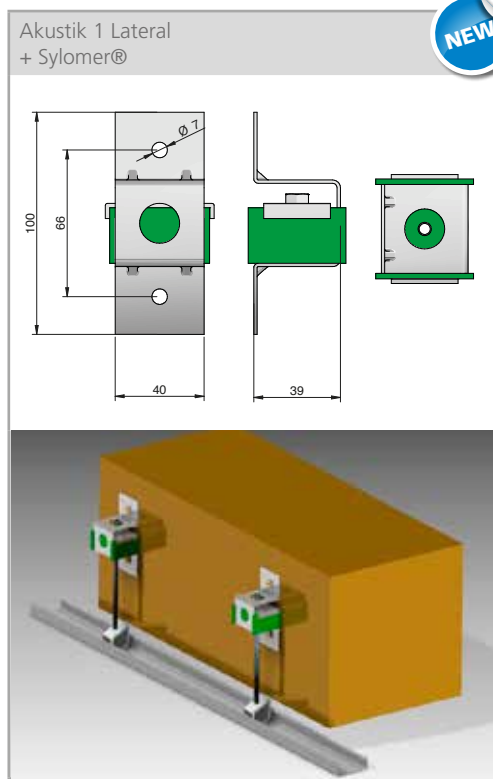

REF. AMC	(Kg) max. load	CODE
Akustik 1 Lateral + Sylomer <sup>®</sup> 30 Type A	30	23573
Akustik 1 Lateral + Sylomer <sup>®</sup> 75 Type A	75	23574
Akustik 1 Lateral + Sylomer <sup>®</sup> 30 Type B	30	23510
Akustik 1 Lateral + Sylomer <sup>®</sup> 75 Type B	75	23526